

DATA SHEET

SKY67183-396LF: 400 to 6000 MHz Broadband Low-Noise Amplifier

Applications

- FDD and TDD 4G LTE and 5G NR systems
- Active antenna array and massive MIMO
- Receive LNA for micro-cell, macro-cell, and small cell base stations
- Land mobile radios and military communications
- Low-noise broadband gain block and driver amplifier

Features

- Low-noise amplifier:
 - Very low noise figure
 - Temperature and process-stable active bias up to +115 °C
 - Wide operating voltage range
 - Low gain slope over operating band
 - Excellent input return loss
- Integrated controller:
 - Stable amplifier bias
 - Temperature compensation
 - True logic level thresholds
 - Fast response time
- Excellent broadband flat gain performance
- Minimal BOM count
- Low current I_{DD} 56 mA @ 5 V
- Fast rise/fall time ENABLE function suitable for TDD application
- Miniature DFN (8-pin, 2 x 2 mm) package (MSL1 @ 260 °C per JEDEC J-STD-020)



Skyworks Green™ products are compliant with all applicable legislation and are halogen-free. For additional information, refer to *Skyworks Definition of Green™*, document number SQ04-0074.

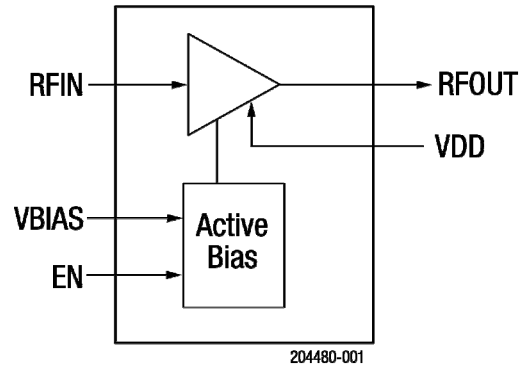

Figure 1. SKY67183-396LF Block Diagram

Description

The SKY67183-396LF is a wide-band low-noise amplifier with superior gain flatness and exceptional linearity.

The compact 2 x 2 mm, 8-pin Dual Flat No Lead packaged LNA is designed for FDD and TDD 4G LTE and 5G NR infrastructure systems operating from 400 to 6000 MHz.

The internal active bias circuitry provides stable performance over temperature and process variation.

A functional block diagram is shown in Figure 1. The pin configuration and package are shown in Figure 2. Signal pin assignments and functional pin descriptions are provided in Table 1.

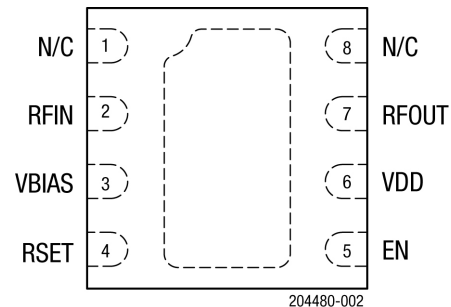

Figure 2. SKY67183-396LF Pinout (Top View)

Table 1. SKY67183-396LF Signal Descriptions

Pin	Name	Description	Pin	Name	Description
1	N/C	No connection (may be connected to ground with no change in performance)	5	EN	Enable voltage to LNA
2	RFIN	RF input (DC blocking capacitor required)	6	VDD	VDD voltage to LNA
3	VBIAS	Bias voltage for input gate	7	RFOUT	RF output. DC blocking capacitor is required.
4	RSET	External resistor to set bias current	8	N/C	No connection (may be connected to ground with no change in performance)

Electrical and Mechanical Specifications

The absolute maximum ratings of the SKY67183-396LF are provided in Table 2. Recommended operating conditions are shown in Table 3. Thermal data is shown in Table 4. Electrical specifications are provided in Tables 5, 6, 7, and 8.

Table 2. SKY67183-396LF Absolute Maximum Ratings¹

Parameter	Symbol	Minimum	Maximum	Units
Supply voltage	VDD		5.5	V
LNA enable	EN	-0.5	2.8	V
Quiescent supply current	I _{DD}		100	mA
RF input power (C/W)	P _{IN}		+22	dBm
Storage temperature	T _{STG}	-40	+150	°C
Operating temperature	T _A	-40	+115	°C
Junction temperature	T _J		+150	°C
Electrostatic discharge:	ESD			
Charged Device Model (CDM), Class C3			1000	V
Human Body Model (HBM), Class 1A			250	V

¹ Exposure to maximum rating conditions for extended periods may reduce device reliability. There is no damage to device with only one parameter set at the limit and all other parameters set at or below their nominal value. Exceeding any of the limits listed here may result in permanent damage to the device.

ESD HANDLING: Industry-standard ESD handling precautions must be adhered to at all times to avoid damage to this device.

Table 3. SKY67183-396LF Recommended Operating Conditions

Parameter	Symbol	Min	Typ	Max	Units
Supply voltage	VDD	3.3	5.0	5.25	V
LNA enable:	EN				
ON			0	0.63	V
OFF		1.17	1.8	2.4	V

Table 4. SKY67183-396LF Electrical Specifications: Thermal Data¹
(V_{DD} = 5.0 V, Enable = GND, T_A = +25 °C, P_{IN} = No RF, Characteristic Impedance [Z₀] = 50 Ω, Unless Otherwise Noted)

Parameter	Symbol	Test Condition	Min	Typ	Max	Units
Thermal resistance	θ _{JC}			79.8		°C/W
Channel temperature @ +115 °C reference (package heat slug)	T _J	V _{DD} = 5.0 V, I _{DQ} = 61 mA, no RF applied, dissipated power = 0.31 W		139		°C

¹ Performance is guaranteed only under the conditions listed in this table.

Table 5. SKY67183-396LF Electrical Specifications: 4200 to 4900 MHz Optimized BoM in Table 8¹
(V_{DD} = 5.0 V, Enable = GND, T_A = +25 °C, P_{IN} = -20 dBm, Characteristic Impedance [Z₀] = 50 Ω, f = 4500 MHz, Unless Otherwise Noted)

Parameter	Symbol	Test Condition	Min	Typ	Max	Units
RF Specifications						
Noise figure	NF	@ 4200 MHz @ 4500 MHz @ 4900 MHz		0.5 0.5 0.6	1.0 1.0 1.1	dB dB dB
Small signal gain	IS211	@ 4200 MHz @ 4500 MHz @ 4900 MHz	16.5	18.2 18.2 17.7		dB dB dB
Input return loss	IS111	@ 4200 MHz @ 4500 MHz @ 4900 MHz	12	16.1 32.8 21.9		dB dB dB
Output return loss	IS221	@ 4200 MHz @ 4500 MHz @ 4900 MHz	10	11.2 23.2 14.9		dB dB dB
Reverse isolation	IS121	@ 4200 MHz @ 4500 MHz @ 4900 MHz	26	32 32 32		dB dB dB
Third order output intercept (-20 dBm input/1 MHz tone)	OIP3	@ 4200 MHz @ 4500 MHz @ 4900 MHz	+27	+29 +29 +28.5		dBm dBm dBm
1 dB output compression point	OP1dB	@ 4200 MHz @ 4500 MHz @ 4900 MHz	+16	+20 +19 +20		dBm dBm dBm
DC Specifications						
Supply voltage	V _{DD}			5.0		V
Quiescent current	I _{DD}		45	56	67	mA
Settling time 0.3 dB ²	TS1	@ 4500 MHz		0.3	0.9	us
Settling time 0.1 dB ³	TS2	@ 4500 MHz		0.31	0.9	us

¹ Performance is guaranteed only under the conditions listed in this table.

² Settling time 0.3 dB is measured from the time the LNA enable reaches 50% of LNA enable "on" level to the time at which the RF output power achieves within 0.3 dB of the average steady-state "on" level.

³ Settling time 0.1 dB is measured from the time the LNA enable reaches 50% of LNA enable "on" level to the time at which the RF output power achieves within 0.1 dB of the average steady-state "on" level.

Typical Performance Characteristics

4200 to 4900 MHz (VDD = 5 V, PIN = -20 dBm, Characteristic Impedance [Zo] = 50 Ω, Unless Otherwise Noted)

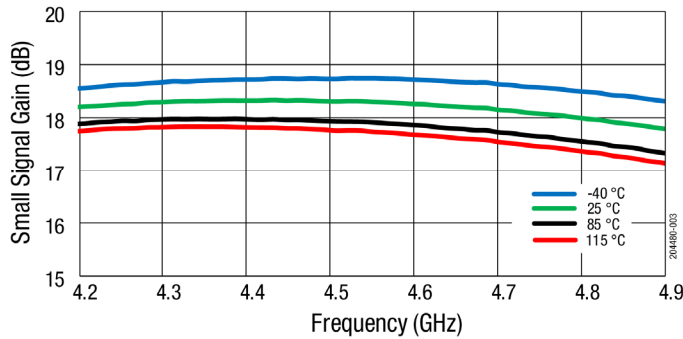

Figure 3. Small Signal Gain (dB) vs Frequency (GHz)

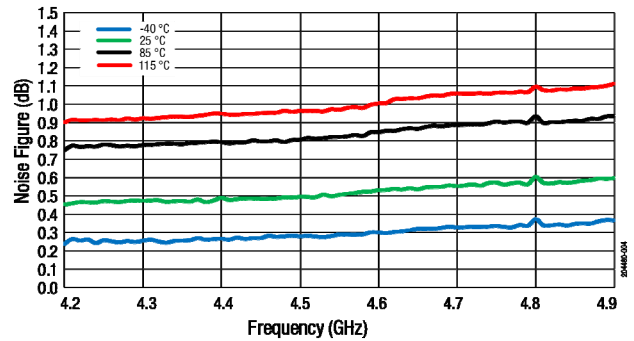

Figure 4. Noise Figure (dB) vs Frequency (GHz)

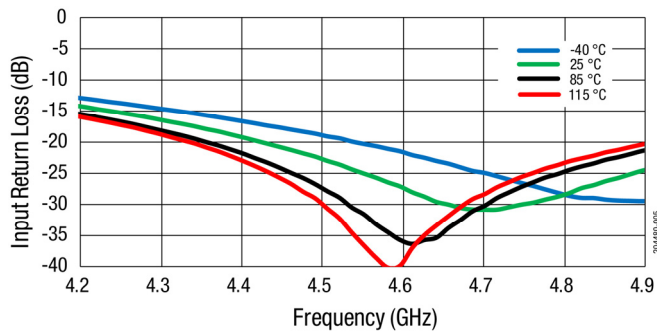

Figure 5. Input Return Loss (dB) vs Frequency

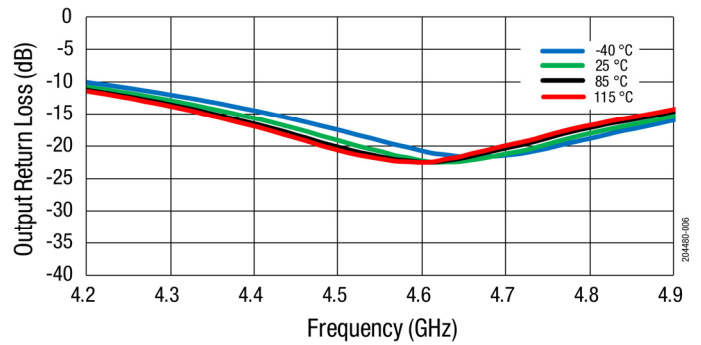

Figure 6. Output Return Loss (dB) vs Frequency

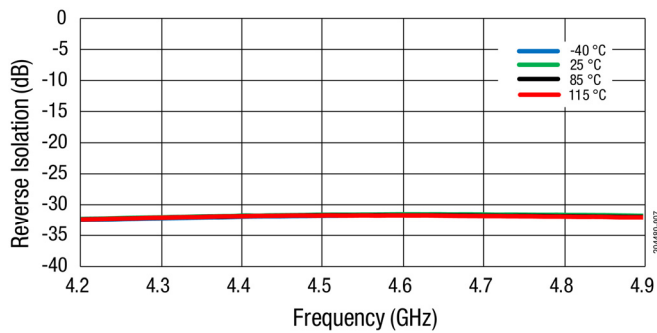

Figure 7. Reverse Isolation (dB) vs Frequency (GHz)

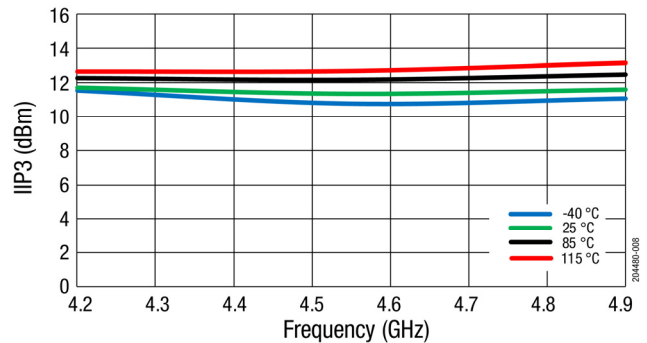

Figure 8. IIP3 (dBm) vs Frequency (GHz)

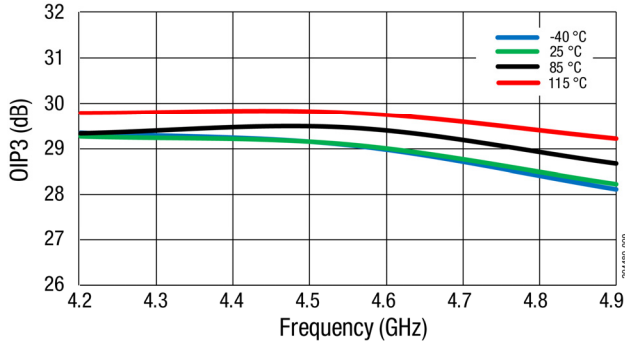

Figure 9. OIP3 (dBm) vs Frequency (GHz)

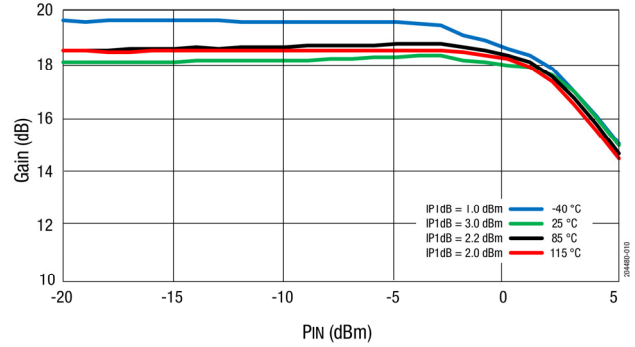

Figure 10. Gain (dB) vs P1dB (dBm)

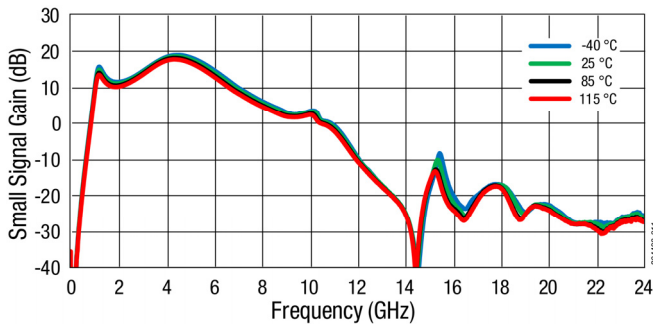

Figure 11. Small Signal Gain (dB) vs Frequency (GHz)

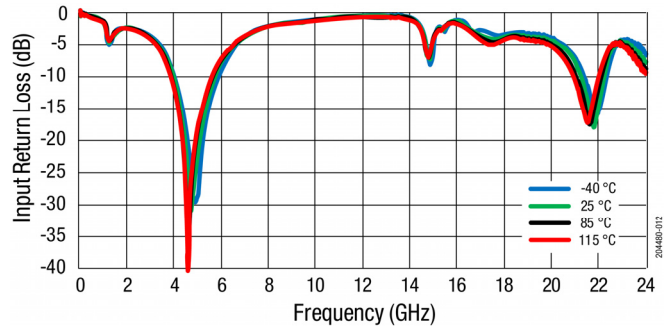

Figure 12. Input Return Loss (dB) vs Frequency (GHz)

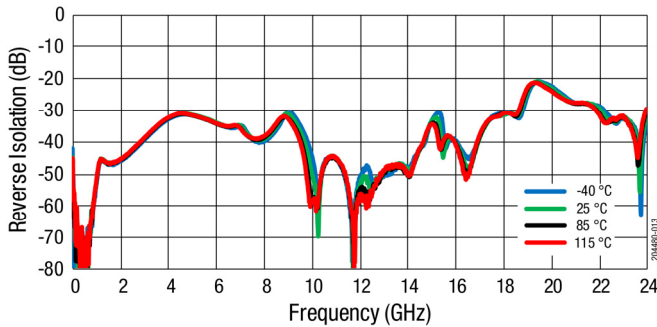

Figure 13. Reverse Isolation (dB) vs Frequency (GHz)

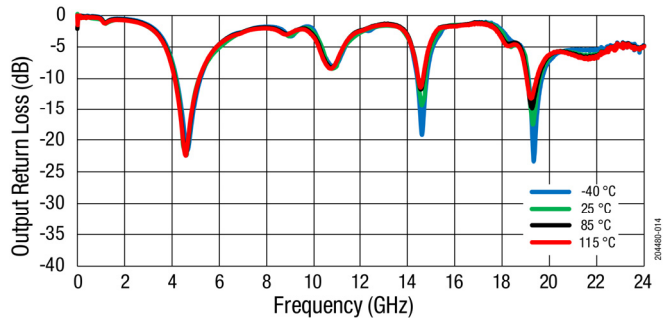

Figure 14. Output Return Loss (dB) vs Frequency (GHz)

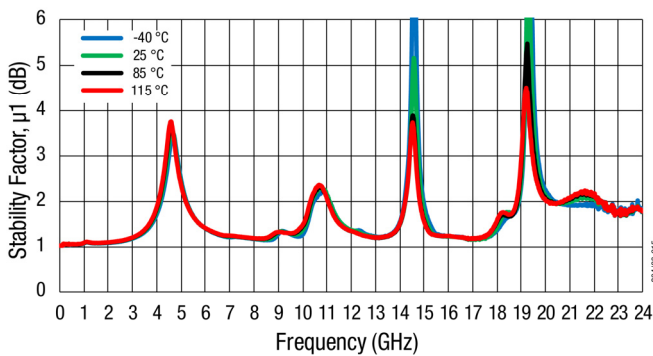

Figure 15. Stability Factor, μ_1 (dB) vs Frequency (GHz)

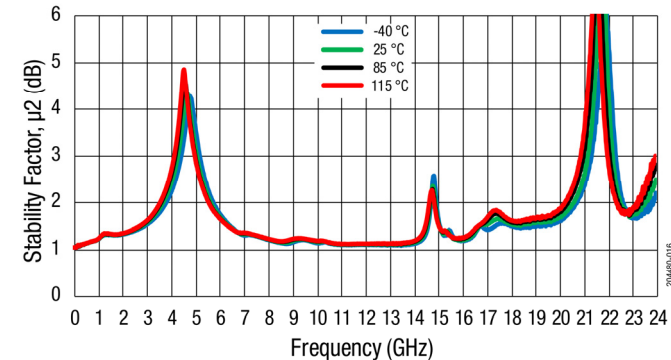

Figure 16. Stability Factor, μ_2 (dB) vs Frequency (GHz)

Table 6. SKY67183-396LF Electrical Specifications: 3300 to 3800 MHz Optimized BOM in Table 9¹
(V_{DD} = 5.0 V, Enable = GND, T_A = +25 °C, P_{IN} = -20 dBm, Characteristic Impedance [Z₀] = 50 Ω, Unless Otherwise Noted)

Parameter	Symbol	Test Condition	Min	Typ	Max	Units
RF Specifications						
Noise figure	NF	@ 3300 MHz @ 3400 MHz @ 3600 MHz @ 3800 MHz		0.42 0.42 0.43 0.49	0.72 0.72 0.72 0.80	dB dB dB dB
Gain	IS21I	@ 3300 MHz @ 3400 MHz @ 3600 MHz @ 3800 MHz	16.9 17.0 17.0 16.9	19.1 19.1 19.1 18.9		dB dB dB dB
Input return loss	IS11I	@ 3300 MHz @ 3400 MHz @ 3600 MHz @ 3800 MHz	9.6 11.2 15.4 18.3	12.3 14.4 20.6 31.9		dB dB dB dB
Output return loss	IS22I	@ 3300 MHz @ 3400 MHz @ 3600 MHz @ 3800 MHz	6.5 7.7 10.1 13.1	9.8 11.8 16.4 19.0		dB dB dB dB
Reverse isolation	IS12I	@ 3300 MHz @ 3400 MHz @ 3600 MHz @ 3800 MHz	29.6 29.4 29.0 28.8	33.1 32.8 32.4 32.1		dB dB dB dB
Third order output intercept point	OIP3	P _{IN} = -20 dBm, Δ Tone = 1 MHz: @ 3300 MHz @ 3400 MHz @ 3600 MHz @ 3800 MHz	27.0 27.1 25.8 28.9	30.3 30.3 28.9 34.7		dBm dBm dBm dBm
1 dB output compression point	OP1dB	@ 3300 MHz @ 3400 MHz @ 3600 MHz @ 3800 MHz	18.1 18.0 17.9 18.4	20.3 20.2 20.1 20.6		dBm dBm dBm dBm
DC Specifications						
Supply voltage	V _{DD}			5.0		V
Quiescent current	I _{DD}		45	56	67	mA
Settling time 0.3 dB ²	T _{S1}	@ 3600 MHz		0.28		us
Settling time 0.1 dB ³	T _{S2}	@ 3600 MHz		0.29		us

¹ Verified by characterization.

² Settling time 0.3 dB is measured from the time the LNA enable reaches 50% of LNA enable "on" level to the time at which the RF output power achieves within 0.3 dB of the average steady-state "on" level.

³ Settling time 0.1 dB is measured from the time the LNA enable reaches 50% of LNA enable "on" level to the time at which the RF output power achieves within 0.1 dB of the average steady-state "on" level.

Typical Performance Characteristics

3300 to 3800 MHz, (VDD = 5 V, TA = +25 °C, PIN = -20 dBm, Characteristic Impedance [Zo] = 50 Ω Unless Otherwise Noted)

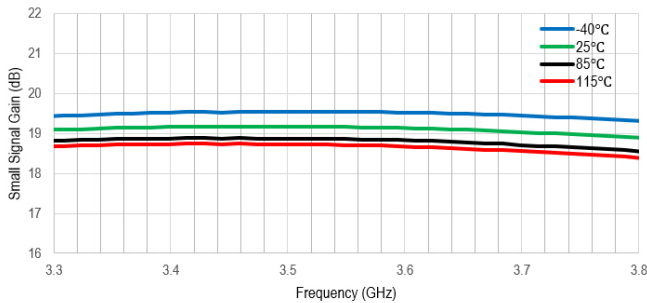

Figure 17. Small Signal Gain (dB) vs Frequency (GHz)

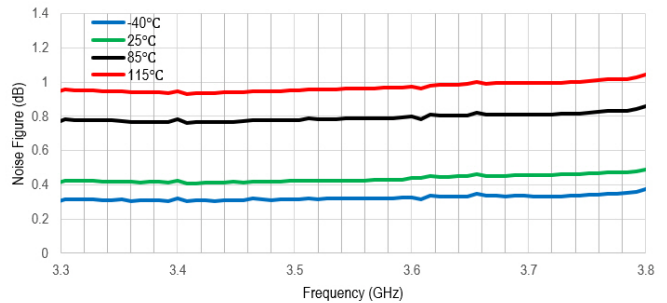

Figure 18. Noise Figure (dB) vs Frequency (GHz)

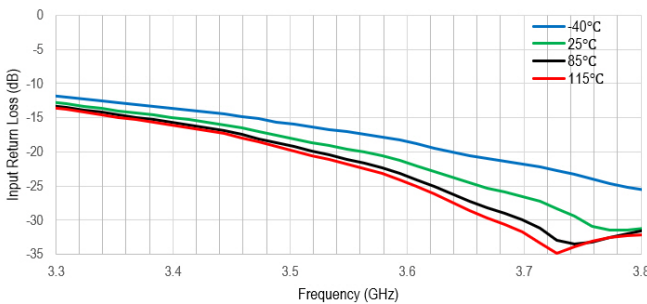

Figure 19. Input Return Loss (dB) vs Frequency (GHz)

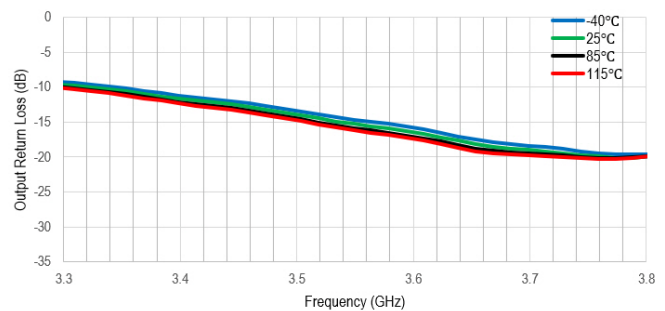

Figure 20. Output Return Loss (dB) vs Frequency (GHz)

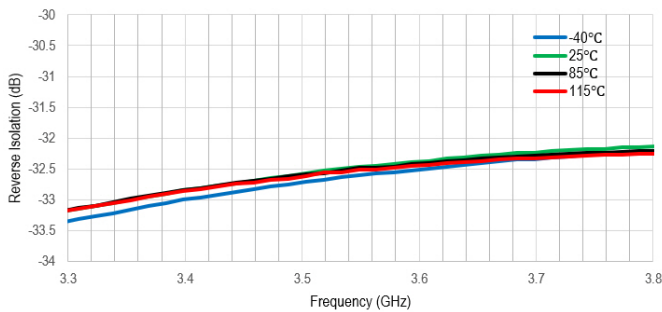

Figure 21. Reverse Isolation (dB) vs Frequency (GHz)

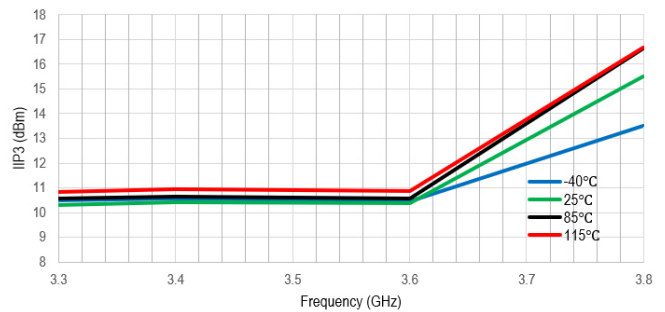

Figure 22. IIP3 (dBm) vs Frequency (GHz)

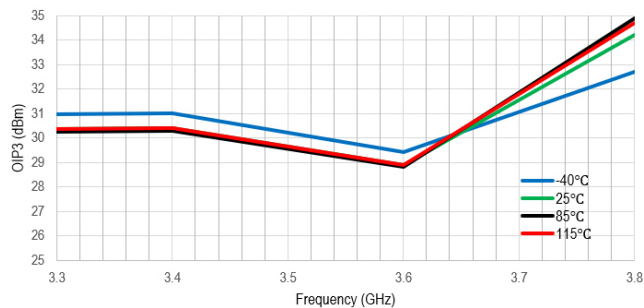

Figure 23. OIP3 (dBm) vs Frequency (GHz)

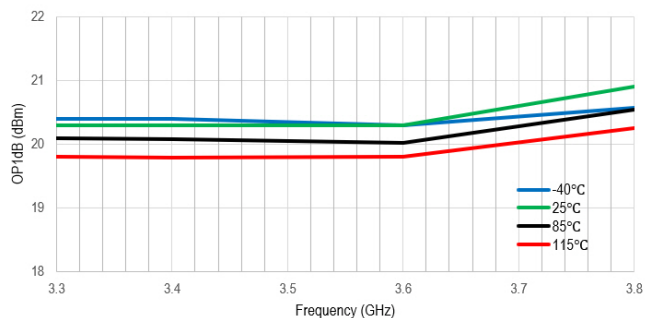

Figure 24. OP1dB (dBm) vs Frequency (GHz)

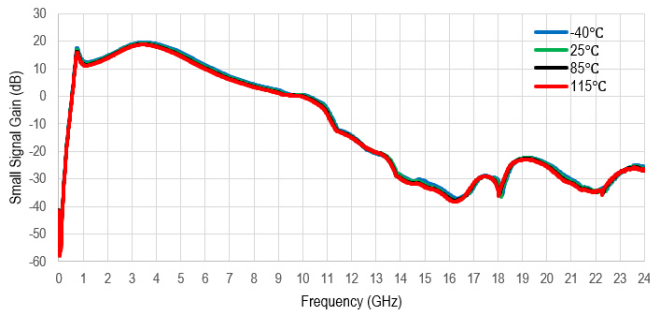

Figure 25. Small Signal Gain (dB) vs Frequency (GHz)

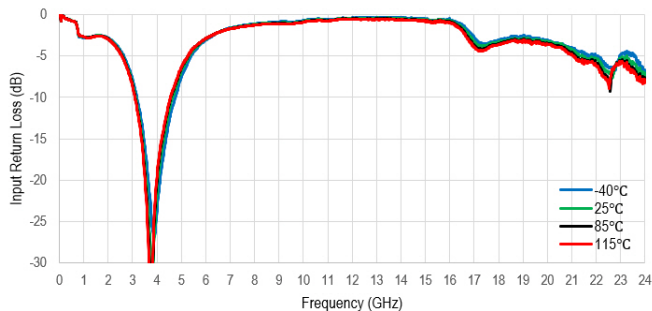

Figure 26. Input Return Loss (dB) vs Frequency (GHz)

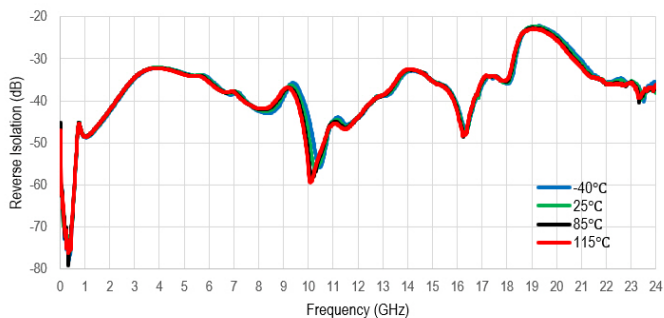

Figure 27. Reverse Isolation (dB) vs Frequency (GHz)

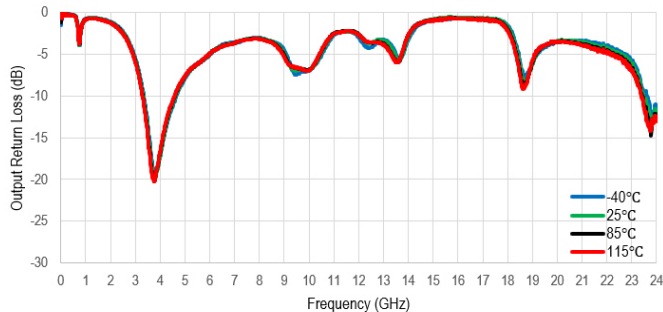

Figure 28. Output Return Loss (dB) vs Frequency (GHz)

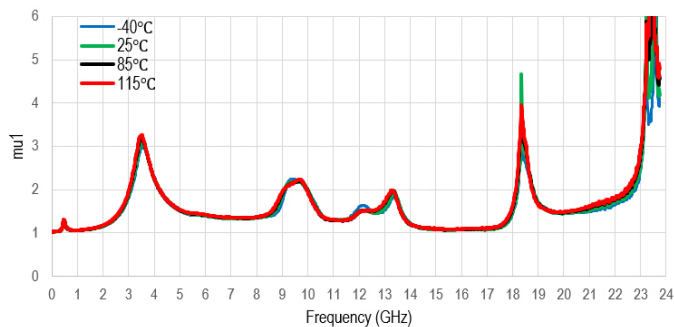

Figure 29. Stability Factor, μ_1 (dB) vs Frequency (GHz)

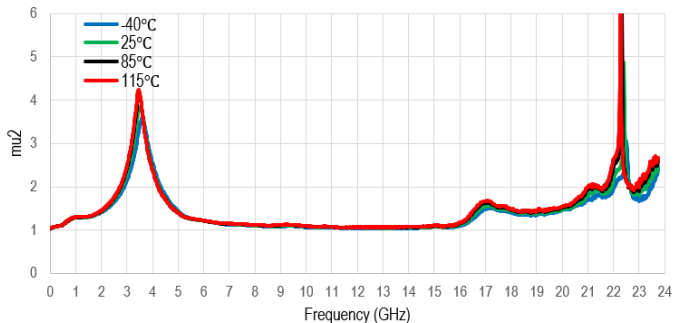

Figure 30. Stability Factor, μ_2 (dB) vs Frequency (GHz)

Table 7. SKY67183-396LF Electrical Specifications: 2300 to 2700 MHz Optimized BoM in Table 10¹
(V_{DD} = 5.0 V, Enable = GND, T_A = +25 °C, P_{IN} = -20 dBm, Characteristic Impedance [Z₀] = 50 Ω, Unless Otherwise Noted)

Parameter	Symbol	Test Condition	Min	Typ	Max	Units
RF Specifications						
Noise figure	NF	@ 2300 MHz		0.36	0.75	dB
		@ 2500 MHz		0.41	0.75	dB
		@ 2700 MHz		0.43	0.85	dB
Gain	IS21I	@ 2300 MHz	20	21.7		dB
		@ 2500 MHz	20	21.4		dB
		@ 2700 MHz	19	20.9		dB
Input return loss	IS11I	@ 2300 MHz	9	13		dB
		@ 2500 MHz	10	16.4		dB
		@ 2700 MHz	10	18.7		dB
Output return loss	IS22I	@ 2300 MHz	7	11.2		dB
		@ 2500 MHz	9	13.5		dB
		@ 2700 MHz	9	12.6		dB
Reverse isolation	IS12I	@ 2300 MHz		33.8		dB
		@ 2500 MHz		33.4		dB
		@ 2700 MHz		33.2		dB
Third order output intercept point	OIP3	P _{IN} = -20 dBm, Δ Tone = 1 MHz:				
		@ 2300 MHz	29	+32.2		dBm
		@ 2500 MHz	29	+32.7		dBm
1 dB output compression point	OP1dB	@ 2300 MHz	18	+19.5		dBm
		@ 2500 MHz	20	+22		dBm
		@ 2700 MHz	20	+22.1		dBm
DC Specifications						
Supply voltage	V _{DD}			5.0		V
Quiescent current	I _{DD}			56		mA
Settling time 0.3 dB ²	T _{S1}	@ 2500 MHz		0.3		us
Settling time 0.1 dB ³	T _{S2}	@ 2500 MHz		0.33		us

¹ Verified by characterization.

² Settling time 0.3 dB is measured from the time the LNA enable reaches 50% of LNA enable "on" level to the time at which the RF output power achieves within 0.3 dB of the average steady-state "on" level.

³ Settling time 0.1 dB is measured from the time the LNA enable reaches 50% of LNA enable "on" level to the time at which the RF output power achieves within 0.1 dB of the average steady-state "on" level.

Typical Performance Characteristics

2300 to 2700 MHz, (VDD = 5 V, TA = +25 °C, PIN = -20 dBm, Characteristic Impedance (Zo) = 50 Ω, Unless Otherwise Noted)

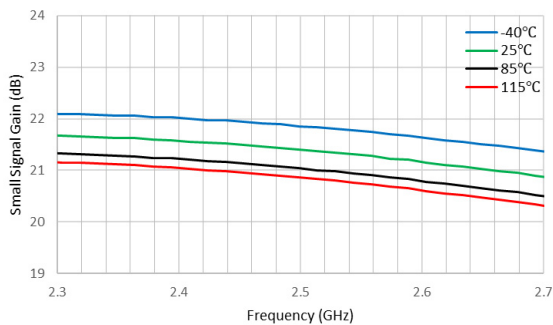

Figure 31. Small Signal Gain (dB) vs Frequency (GHz)

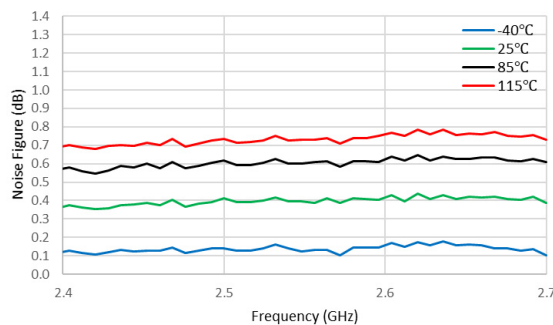

Figure 32. Noise Figure (dB) vs Frequency (GHz)

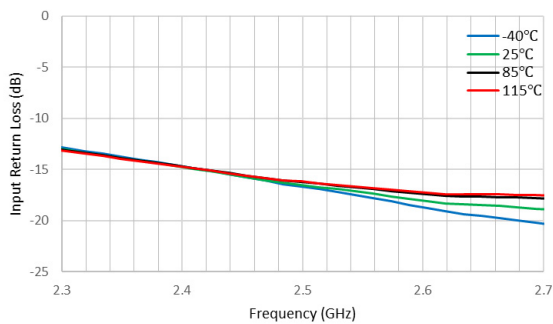

Figure 33. Input Return Loss (dB) vs Frequency

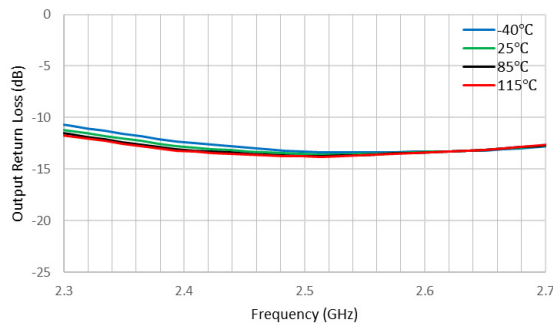

Figure 34. Output Return Loss (dB) vs Frequency

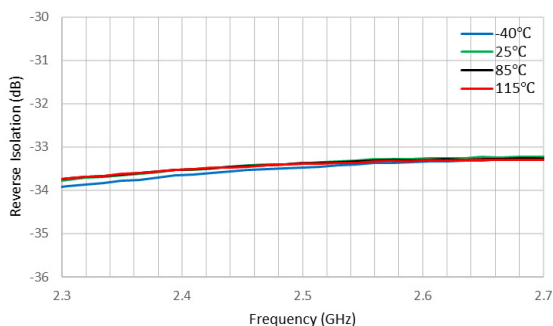

Figure 35. Reverse Isolation (dB) vs Frequency (GHz)

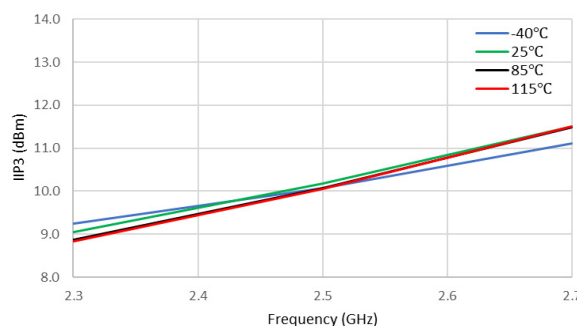

Figure 36. IIP3 (dBm) vs Frequency (GHz)

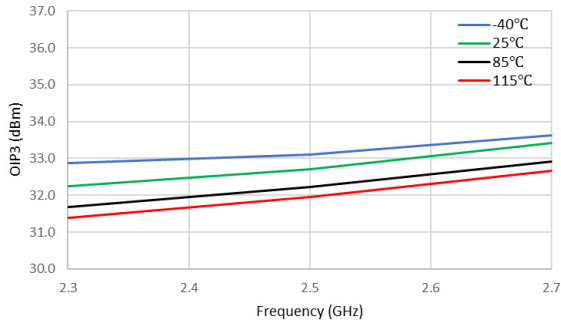

Figure 37. OIP3 (dBm) vs Frequency (GHz)

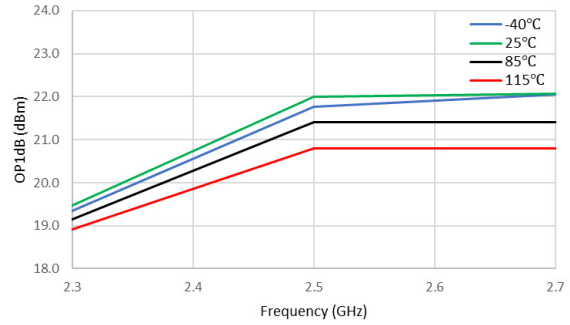

Figure 38. OP1dB (dBm) vs Frequency (GHz)

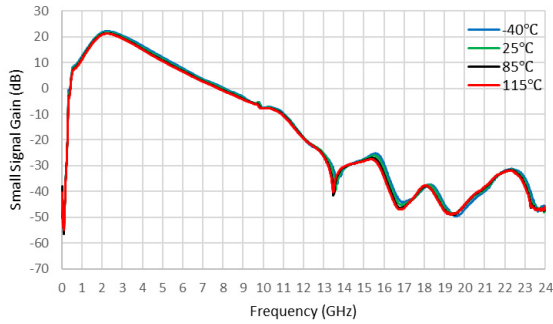

Figure 39. Small Signal Gain (dB) vs Frequency (GHz)

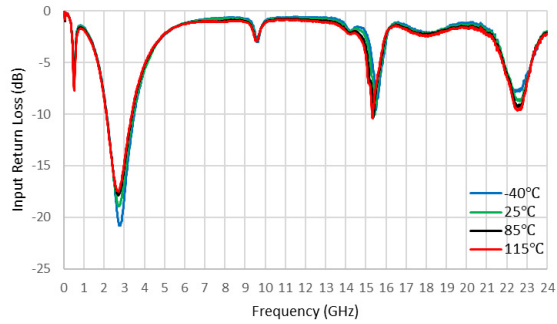

Figure 40. Input Return Loss (dB) vs Frequency (GHz)

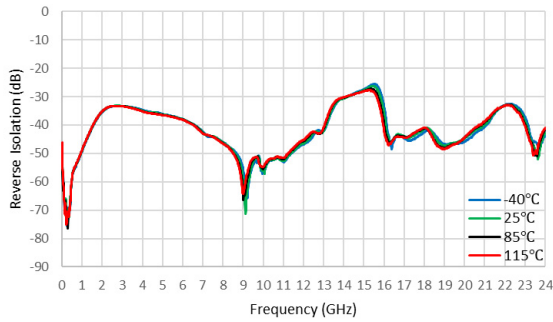

Figure 41. Reverse Isolation (dB) vs Frequency (GHz)

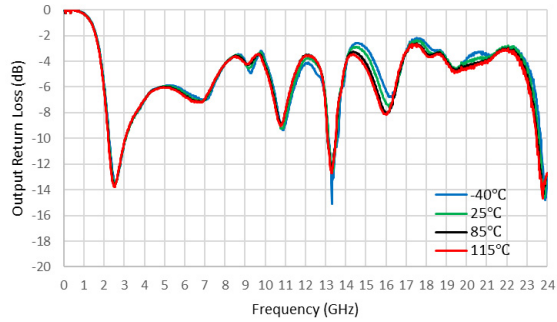

Figure 42. Output Return Loss (dB) vs Frequency (GHz)

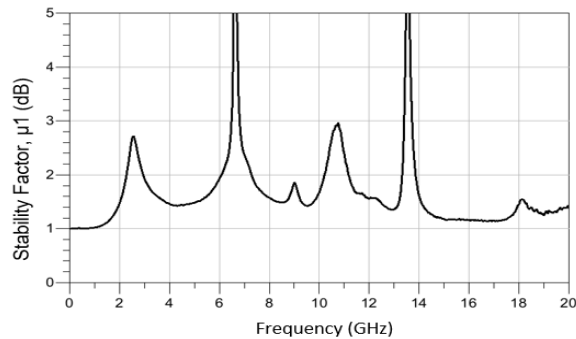

Figure 43. Stability Factor, μ_1 (dB) vs Frequency (GHz) at -40 °C

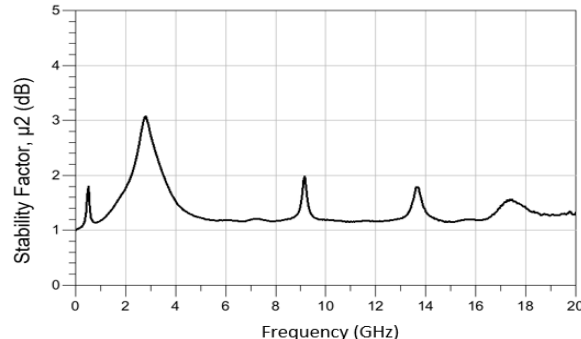

Figure 44. Stability Factor, μ_2 (dB) vs Frequency (GHz) at -40 °C

Table 8. SKY67183-396LF Electrical Specifications: 1700 to 2200 MHz Optimized BOM in Table 10¹
(VDD = 5.0 V, Enable = GND, TA = +25 °C, PIN = -20 dBm, Characteristic Impedance [Z0] = 50 Ω, Unless Otherwise Noted)

Parameter	Symbol	Test Condition	Min	Typ	Max	Units
RF Specifications						
Noise figure	NF	@ 1700 MHz		0.34	0.75	dB
		@ 1950 MHz		0.38	0.75	dB
		@ 2200 MHz		0.41	0.85	dB
Gain	IS21I	@ 1700 MHz	21.5	23.2		dB
		@ 1950 MHz	21	22.7		dB
		@ 2200 MHz	19.5	21.5		dB
Input return loss	IS11I	@ 1700 MHz	10	15.7		dB
		@ 1950 MHz	10	26.2		dB
		@ 2200 MHz	10	14.8		dB
Output return loss	IS22I	@ 1700 MHz	7	9.7		dB
		@ 1950 MHz	10	25.2		dB
		@ 2200 MHz	10	20.6		dB
Reverse isolation	IS12I	@ 1700 MHz		34.4		dB
		@ 1950 MHz		34.2		dB
		@ 2200 MHz		34.6		dB
Third order output intercept point	OIP3	PIN = -20 dBm, Δ Tone = 1 MHz: @ 1700 MHz	28	+31.8		dBm
		@ 1950 MHz	28	+32.2		dBm
		@ 2200 MHz	28	+32.5		dBm
1 dB output compression point	OP1dB	@ 1700 MHz	17.5	+19.1		dBm
		@ 1950 MHz	18.0	+20.2		dBm
		@ 2200 MHz	19.0	+21.1		dBm
DC Specifications						
Supply voltage	VDD			5		V
Quiescent current	IDD			56		mA
Settling time 0.3 dB ²	TS1	@ 1950 MHz		0.3		us
Settling time 0.1 dB ³	TS2			0.33		us

¹ Verified by characterization.

² Settling time 0.3 dB is measured from the time the LNA enable reaches 50% of LNA enable "on" level to the time at which the RF output power achieves within 0.3 dB of the average steady-state "on" level.

³ Settling time 0.1 dB is measured from the time the LNA enable reaches 50% of LNA enable "on" level to the time at which the RF output power achieves within 0.1 dB of the average steady-state "on" level.

Typical Performance Characteristics
1700 to 2200 MHz (VDD = 5 V, PIN = -20 dBm, Characteristic Impedance [Zo] = 50 Ω, Unless Otherwise Noted)

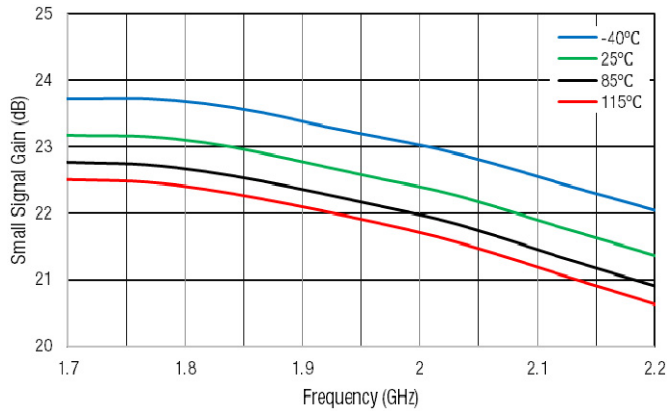

Figure 45. Small Signal Gain (dB) vs Frequency (GHz)

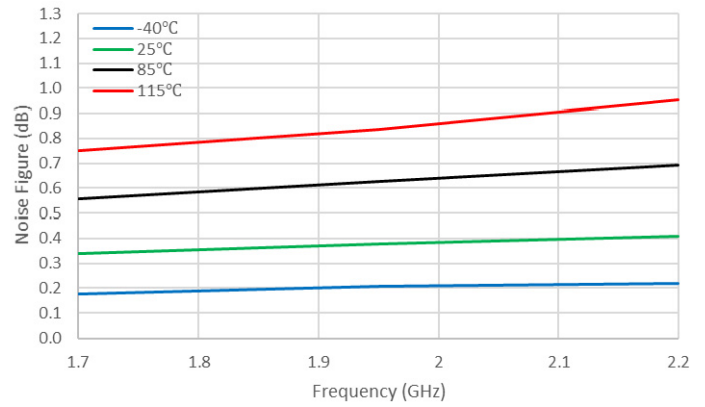

Figure 46. Noise Figure (dB) vs Frequency (GHz)

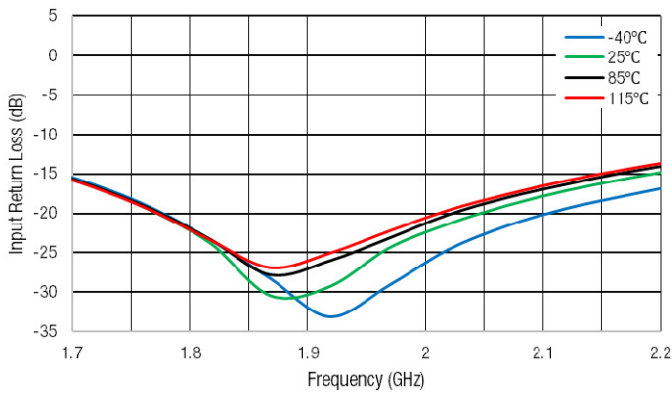

Figure 47. Input Return Loss (dB) vs Frequency

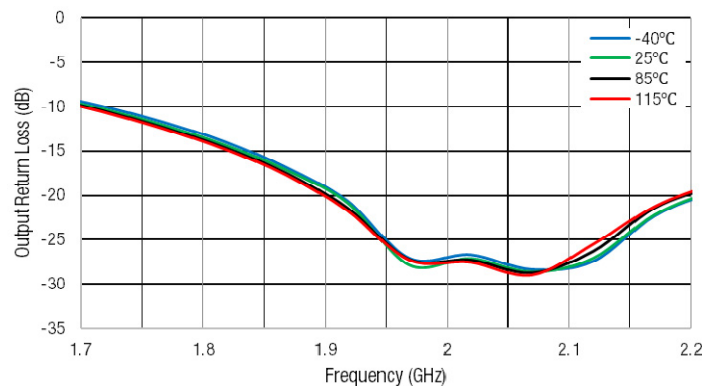

Figure 48. Output Return Loss (dB) vs Frequency

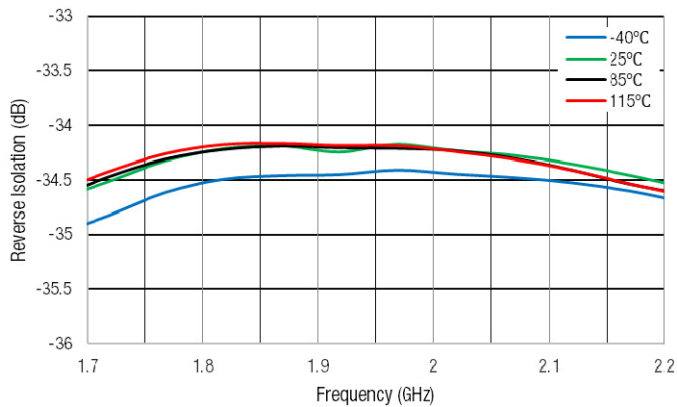

Figure 49. Reverse Isolation (dB) vs Frequency (GHz)

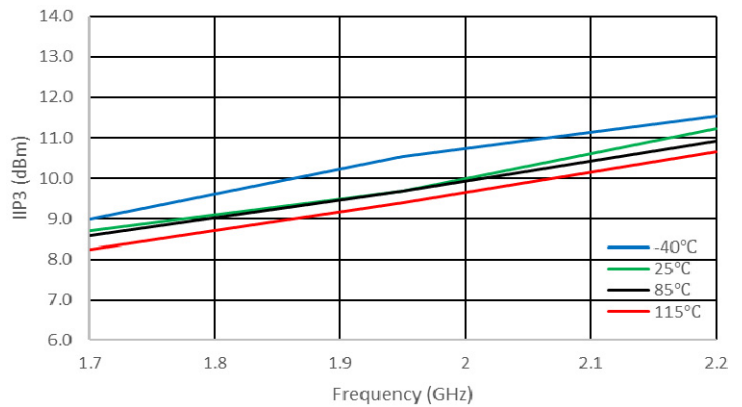

Figure 50. IIP3 (dBm) vs Frequency (GHz)

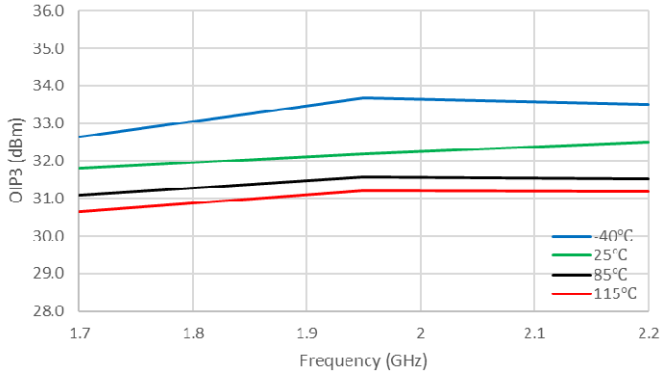

Figure 51. OIP3 (dBm) vs Frequency (GHz)

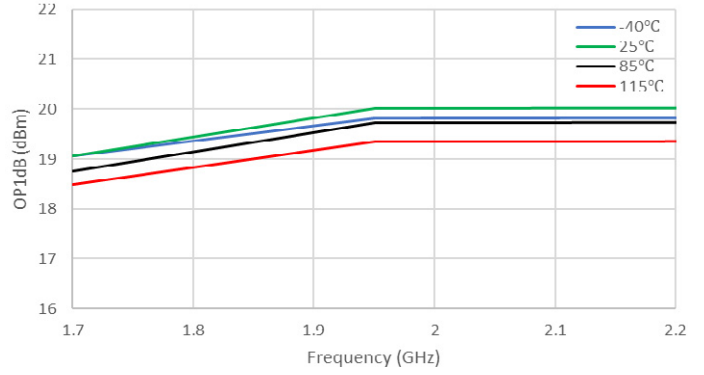

Figure 52. OP1dB (dBm) vs Frequency (GHz)

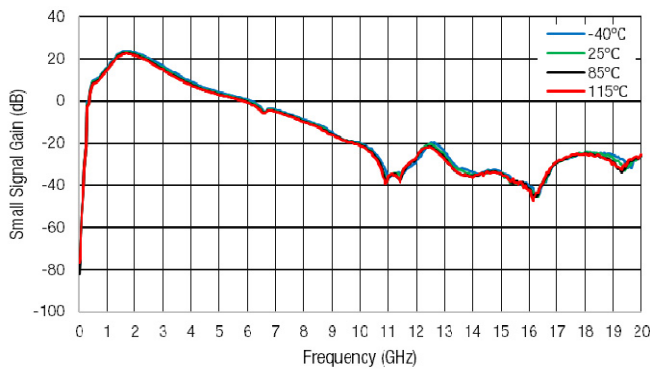

Figure 53. Small Signal Gain (dB) vs Frequency (GHz)

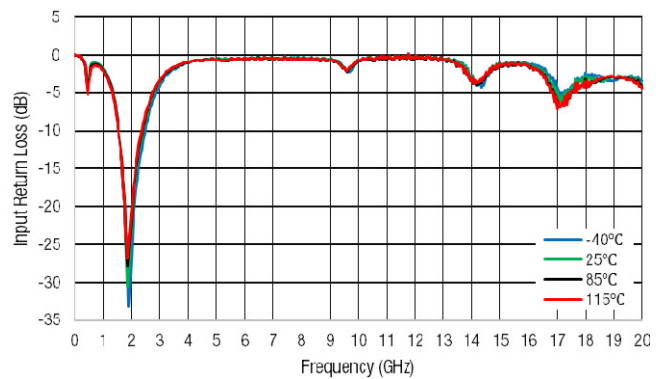

Figure 54. Input Return Loss (dB) vs Frequency (GHz)

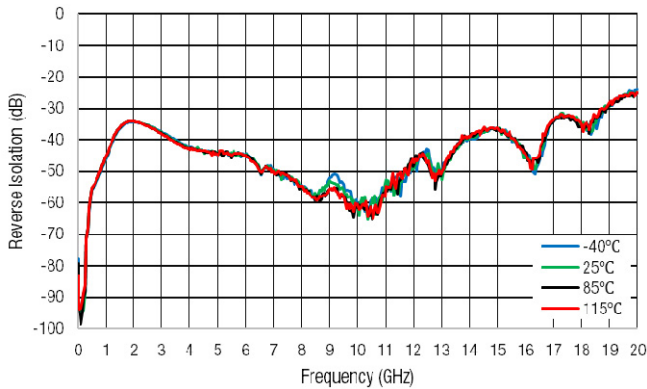

Figure 55. Reverse Isolation (dB) vs Frequency (GHz)

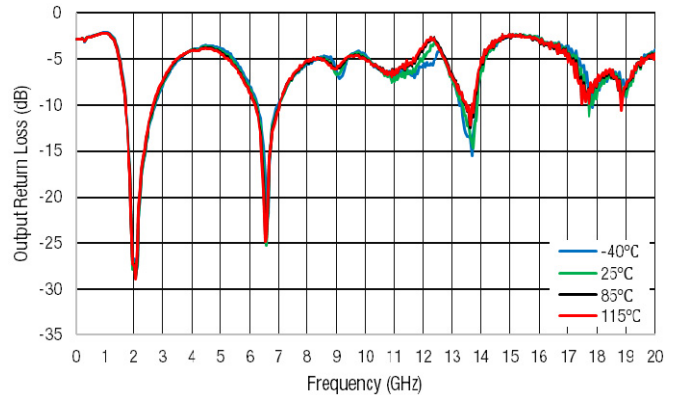

Figure 56. Output Return Loss (dB) vs Frequency (GHz)

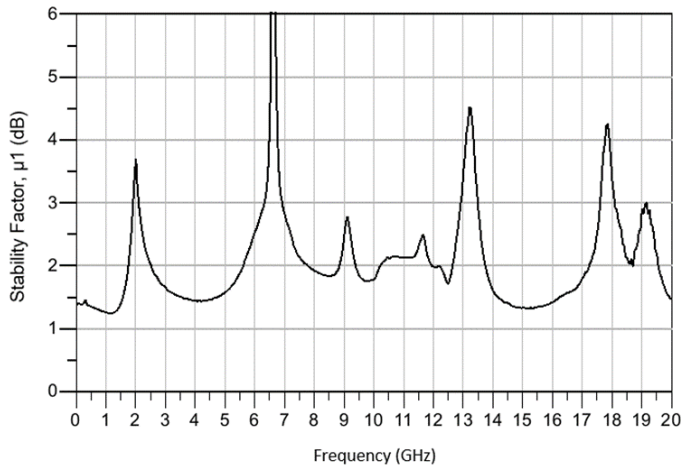

Figure 57. Stability Factor, μ_1 (dB) vs Frequency (GHz) at -40 °C

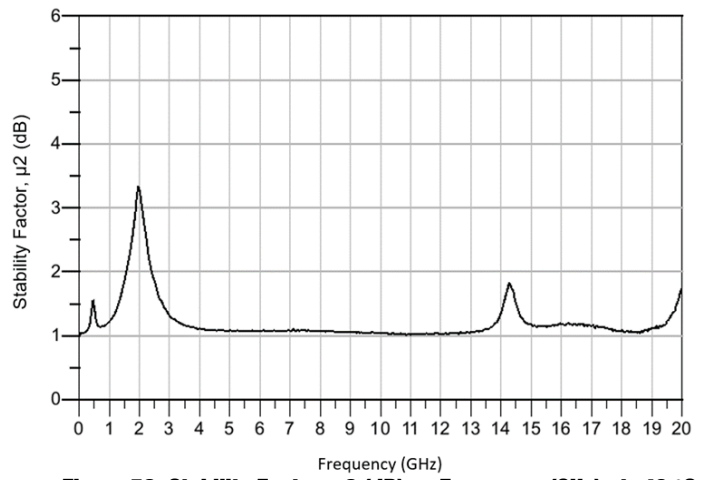

Figure 58. Stability Factor, μ_2 (dB) vs Frequency (GHz) at -40 °C

Evaluation Board Description

The SKY67183-396LF Evaluation Board is used to test the performance of the SKY67183-396LF LNA. An Evaluation Board schematic diagram is shown below. Bill of Materials (BOMs) for

Evaluation Boards optimized for 4200 to 4900 MHz, 3300 to 3800, 2300 to 2700 MHz, and 1700 to 2200 MHz appear in the following pages. An EVB assembly diagram and layer details are also included in this data sheet.

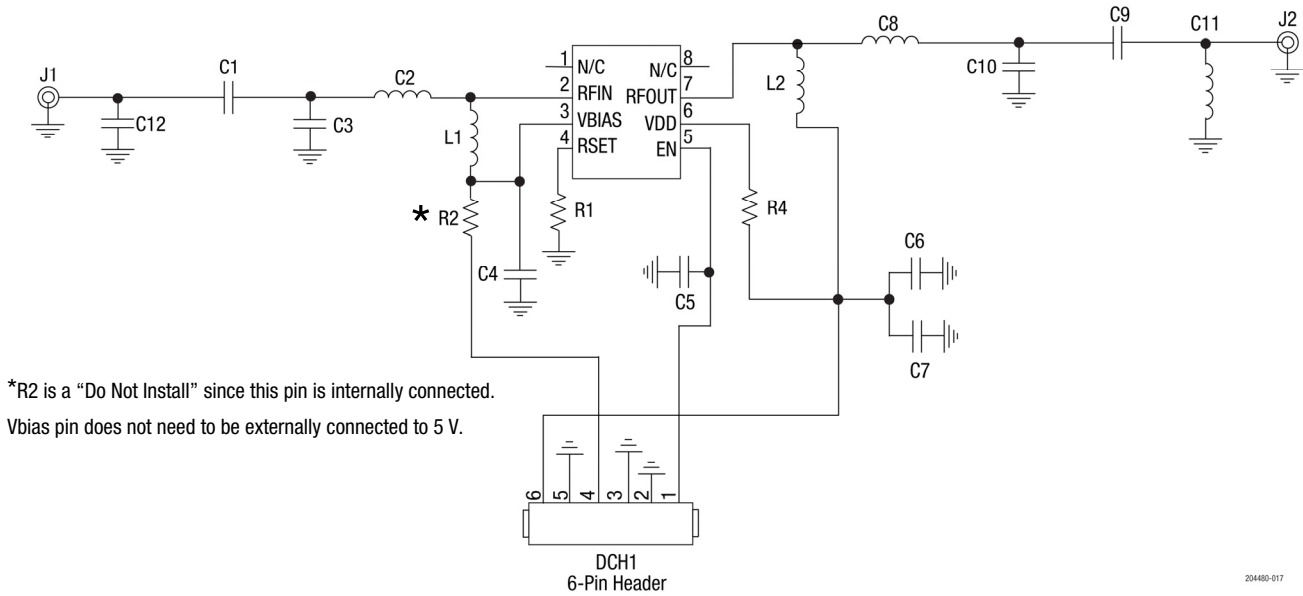

Figure 59. SKY67183-396LF Evaluation Board Schematic

Table 9. SKY67183-396 Evaluation Board Bill of Materials (BOM) for 4200 to 4900 MHz Tuning

Component	Value	Size	Part Number
C1	1.8 pF	0402	GJM1555C1H1R8BB01D
C2	0.8 nH	03015	LQW04ANON8C00D
C3	0.4 pF	0402	GJM1555C1HR40WB01D
C4	DNI		
C5	DNI		
C6	DNI		
C7	4.7 uF	0402	GRM155C80J475MEAAD
C8	2.2 pF	0402	GRM1555C1H2R2BA01D
C9	0 Ω	0402	Not critical
C10	1.0 nH	0402	LQG15HS1N0S02D
C11	DNI		
C12	DNI		
L1	18 nH	0402	LQW15AN18NG8ZD
L2	6.2 nH	0402	LQG15HS6N2S02D
R1	8.2 kΩ	0201	Not critical
R2	DNI		
R4	100 Ω	0201	Not critical

Table 10. SKY67183-396LF Evaluation Board Bill of Materials (BOM) for 3300 to 3800 MHz Tuning

Component	Value	Size	Part Number
C1	1.8 pF	0402	GJM1555C1H1R8BB01
C2	1.8 nH	0402	LQW15AN1N8C00
C3	0.4 pF	0402	GJM1555C1HR40WB01D
C4	DNI		
C5	DNI		
C6	DNI		
C7	4.7 uF	0402	GRM155C80J475MEAAD
C8	5.6 pF	0402	GRM1555C1H5R6BA01D
C9	0 Ω	0402	Not critical
C10	1.8 nH	0402	LQG15HS1N8S02D
C11	DNI		
C12	DNI		
L1	12 nH	0402	LQW15AN12NG8ZD
L2	5.6 nH	0402	LQG15HS5N6S02D
R1	8.2 kΩ	0201	Not critical
R2	DNI		
R4	100 Ω	0201	Not critical

Table 11. SKY67183-396LF Evaluation Board Bill of Materials (BOM) for 2300 to 2700 MHz Tuning

Component	Value	Size	Part Number
C1	5.0 pF	0402	GJM1555C1H5R0BB01D
C2	2.7 nH	0402	LQW15AN2N7B8ZD
C3	0.4 pF	0402	GJM1555C1HR40WB01D
C4	10 pF	0402	GRM1555C1H100JA01D
C5	DNI		
C6	DNI		
C7	4.7 uF	0402	GRM155C80J475MEAAD
C8	22 pF	0402	GRM1555C1H220JA01
C9	1.8 pF	0402	GRM1555C1H1R8BA01D
C10	3.3 nH	0402	LQG15HS3N3S02D
C11	DNI		
C12	DNI		
L1	22 nH	0402	LQW15AN22NG8ZD
L2	5.6 nH	0402	LQG15HS5N6S02D
R1	8.2 kΩ	0201	Not critical
R2	DNI		
R4	100 Ω	0201	Not critical

Table 12. SKY67183-396LF Evaluation Board Bill of Materials (BOM) for 1700 to 2200 MHz Tuning

Component	Value	Size	Part Number
C1	5.0 pF	0402	GJM1555C1H5R0BB01D
C2	4.7 nH	0402	LQW15AN4N7B8ZD
C3	0.4 pF	0402	GJM1555C1HR40WB01D
C4	15 pF	0402	GRM1555C1H150JA01D
C5	DNI		
C6	DNI		
C7	4.7 uF	0402	GRM155C80J475MEAAD
C8	22 pF	0402	GRM1555C1H220JA01
C9	1.8 pF	0402	GRM1555C1H1R8BA01D
C10	6.2 nH	0402	LQG15HS6N2S02D
C11	300 Ohm	0402	ERJ-2RKF3000C
C12	DNI		
L1	22 nH	0402	LQW15AN22NG8ZD
L2	5.6 nH	0402	LQG15HS5N6S02D
R1	8.2 KOhm	0201	ERJ-1GNF8201C
R2	DNI		
R4	100 Ohm	0201	ERJ-1GNF1000C

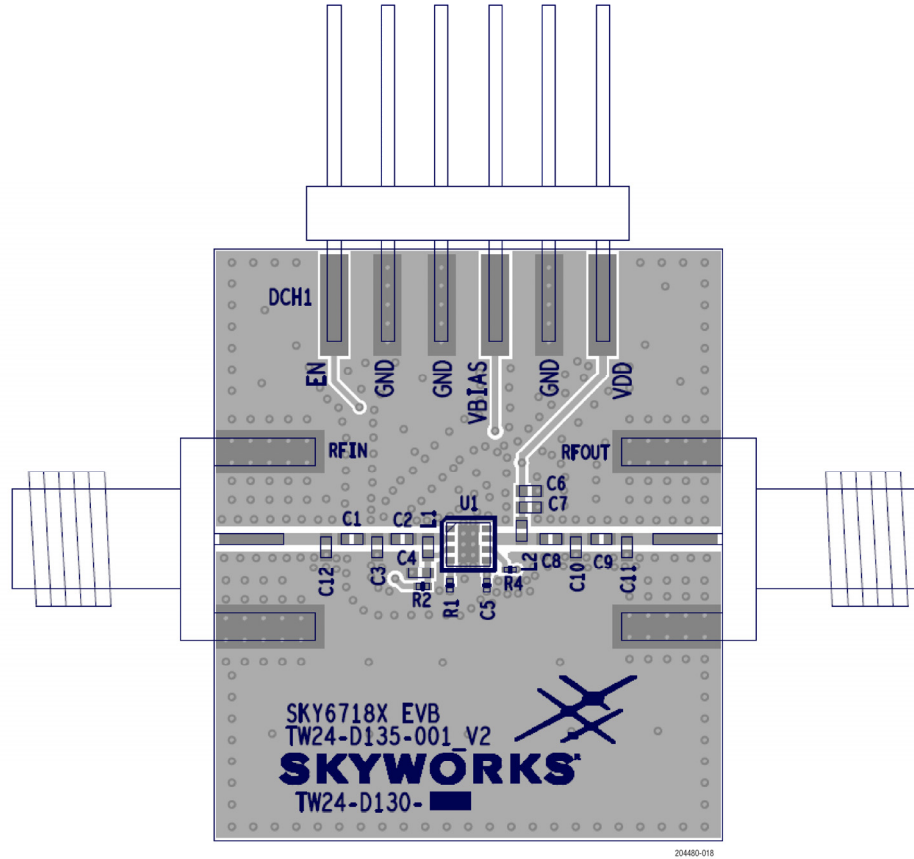

Figure 60. SKY67183-396LF EVB Assembly Diagram

50-OHM TRACE	50-OHM TRACE	CROSS SECTION	NAME	THICKNESS	MATERIALS
$W=0.301\text{mm}$ $S=0.100\text{mm}$	TOL: +/- 5% $W=0.508\text{mm}$ $CPW = 0.375\text{mm}$	TMASK	0.020mm	SOLDER RESIST	
		L1	0.047mm	FINISHED Cu.	
$W=N/A$ $S=N/A$	$W=N/A$ $CPW = N/A$	CORE	0.254mm	RO4350B	
		L2	0.018mm	Cu-0.5oz.	
		PREPREG	0.900mm	FR4 (4.34)	
		L3	0.018mm	Cu-0.5oz.	
		CORE	0.254mm	FR4 (4.34)	
		L4	0.047mm	FINISHED Cu.	
		BMASK	0.020mm	SOLDER RESIST	
TOTAL THICKNESS			1.578mm	TOL: +/- 10%	

204480-019

Figure 61. SKY67183-396LF EVB Layer Details

Package Dimensions

Typical part marking and PCB layout footprint for the SKY67183-396LF appear below, followed by package and tape and reel dimensions.

Package and Handling Information

Instructions on the shipping container label regarding exposure to moisture after the container seal is broken must be followed. Otherwise, problems related to moisture absorption may occur when the part is subjected to high temperature during solder assembly.

The SKY67183-396LF is rated to Moisture Sensitivity Level 1 (MSL1) at 260 °C. It can be used for lead or lead-free soldering. For additional information, refer to the Skyworks Application Note, *Solder Reflow Information*, document number 200164.

Care must be taken when attaching this product, whether it is done manually or in a production solder reflow environment. Production quantities of this product are shipped in a standard tape and reel format.

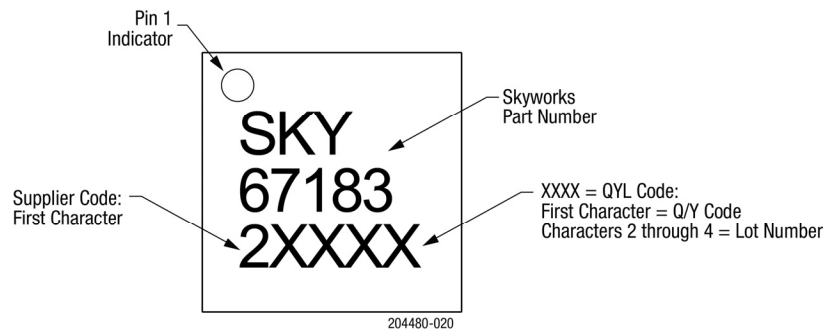
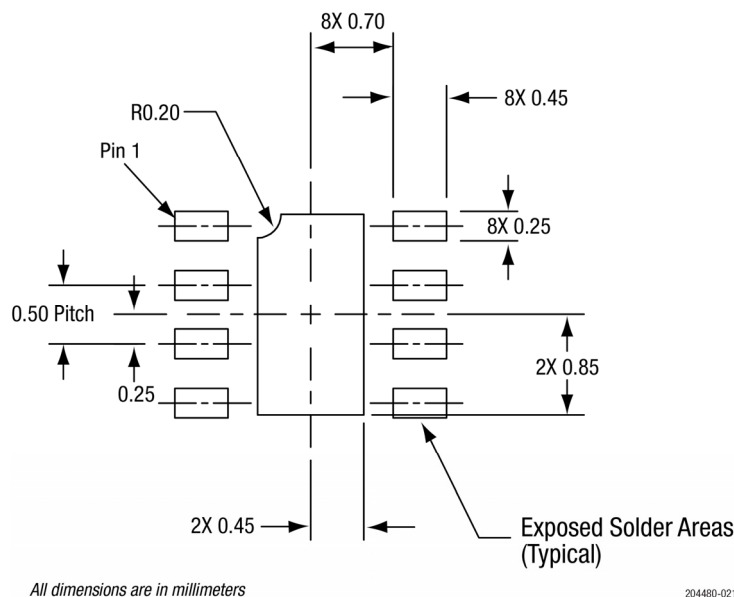
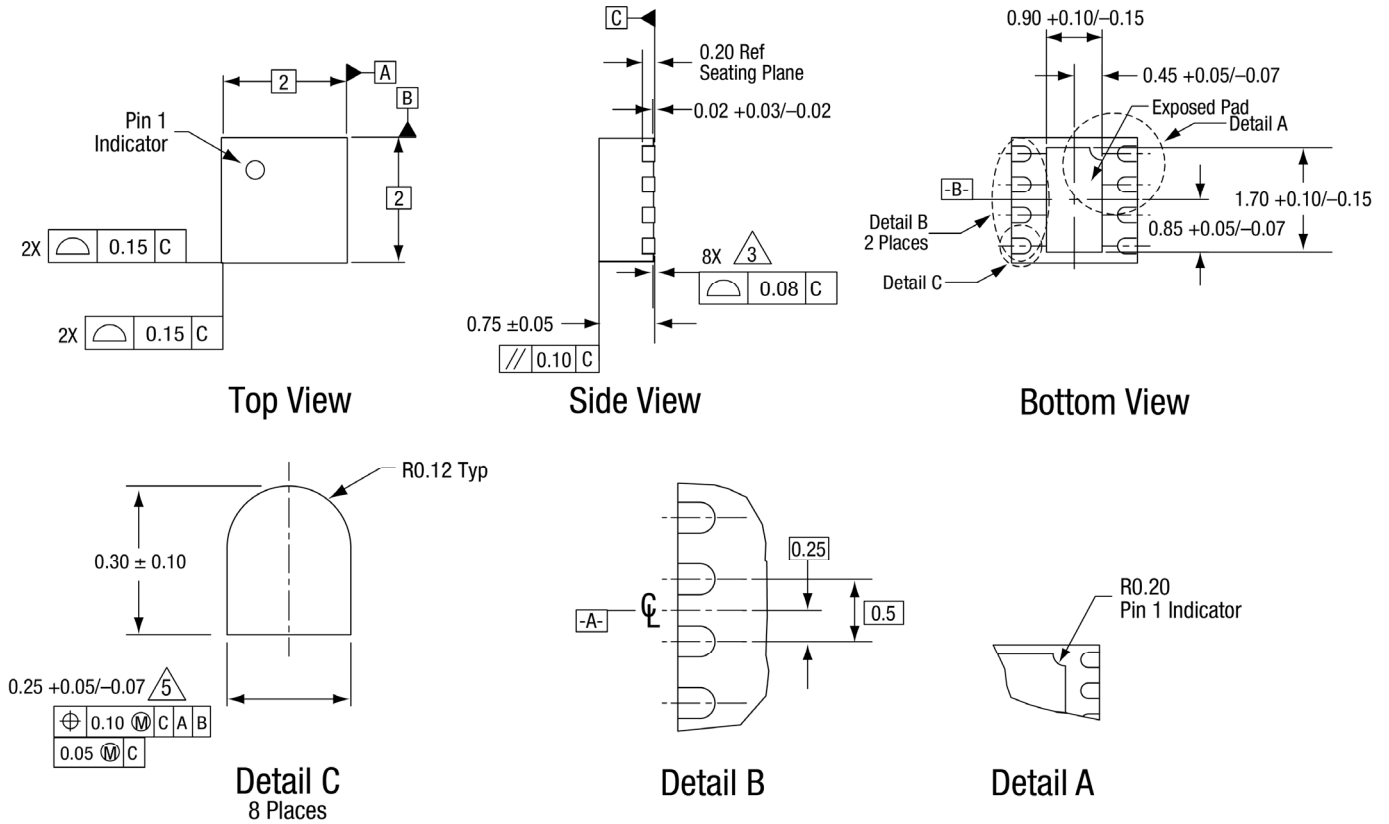

Figure 62. SKY67183-396LF Typical Part Marking



All dimensions are in millimeters

Figure 63. SKY67183-396LF PCB Layout Footprint



Notes:

1. All measurements are in millimeters.
2. Dimensions and tolerances according to ASME Y14.5M-1994.
3. Coplanarity applies to the exposed heat sink ground pad as well as the terminals.
4. Plating requirement per source control drawing (SCD) 2504.
5. Dimension applies to metallized terminal and is measured between 0.15 mm and 0.30 mm from terminal tip.

204480-022

Figure 64. SKY67183-396LF Package Dimensions

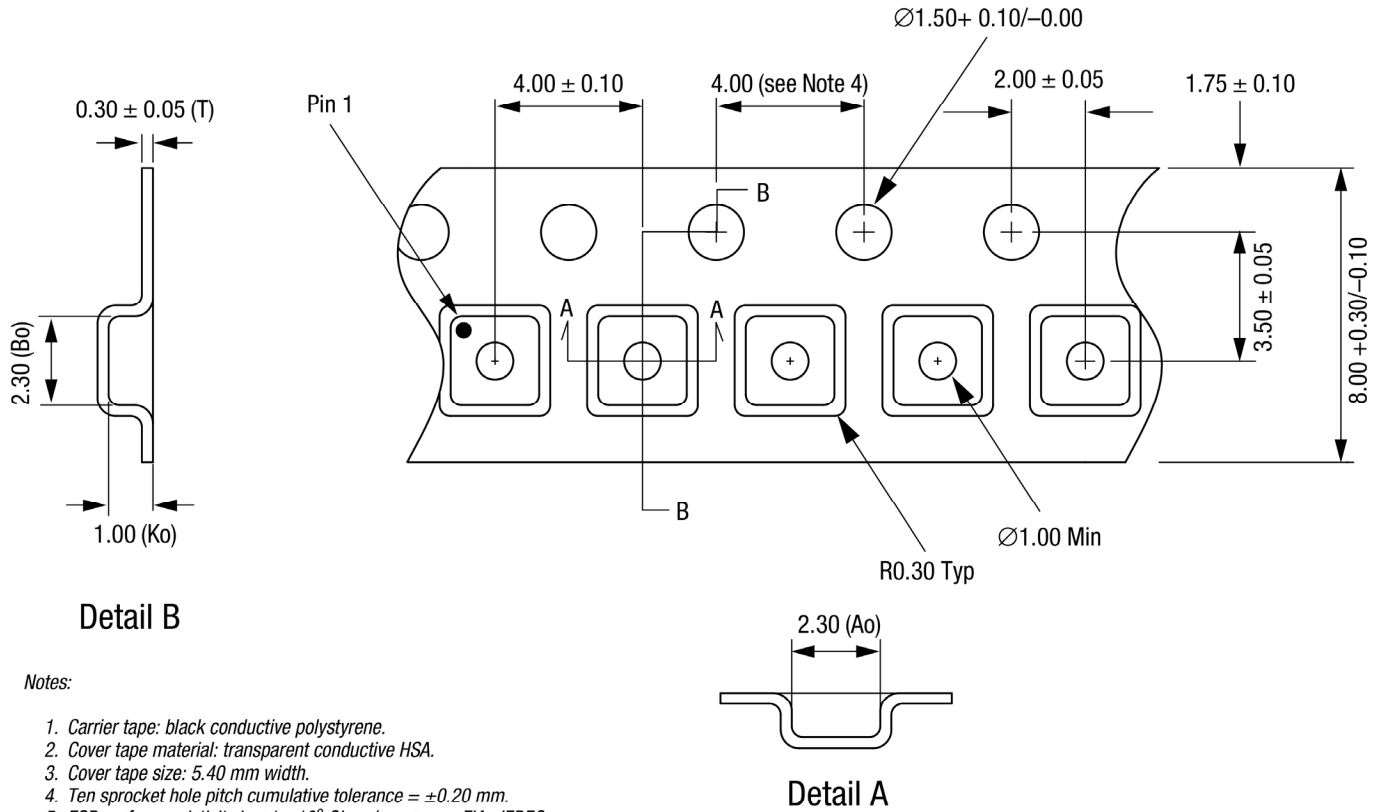

Notes:

1. Carrier tape: black conductive polystyrene.
2. Cover tape material: transparent conductive HSA.
3. Cover tape size: 5.40 mm width.
4. Ten sprocket hole pitch cumulative tolerance = ± 0.20 mm.
5. ESD surface resistivity is $\leq 1 \times 10^8$ Ohms/square per EIA, JEDEC tape and reel specification.
6. Ao and Bo measurement point to be 0.30 mm from bottom pocket.
7. All measurements are in millimeters.

204480-023

Figure 65. SKY67183-396LF Tape and Reel Dimensions

Ordering Information

Part Number	Product Description	Evaluation Board Part Number
SKY67183-396LF	400 to 6000 MHz Broadband Low-Noise Amplifier	SKY67183-396EK1 (4.2 to 4.9 GHz Tuning) SKY67183-396EK2 (3.3 to 3.8 GHz Tuning) SKY67183-396EK3 (2.3 to 2.7 GHz Tuning) SKY67183-396EK4 (1.7 to 2.2 GHz Tuning)

Copyright © 2021-2022 Skyworks Solutions, Inc. All Rights Reserved.

Information in this document is provided in connection with Skyworks Solutions, Inc. (“Skyworks”) products or services. These materials, including the information contained herein, are provided by Skyworks as a service to its customers and may be used for informational purposes only by the customer. Skyworks assumes no responsibility for errors or omissions in these materials or the information contained herein. Skyworks may change its documentation, products, services, specifications or product descriptions at any time, without notice. Skyworks makes no commitment to update the materials or information and shall have no responsibility whatsoever for conflicts, incompatibilities, or other difficulties arising from any future changes.

No license, whether express, implied, by estoppel or otherwise, is granted to any intellectual property rights by this document. Skyworks assumes no liability for any materials, products or information provided hereunder, including the sale, distribution, reproduction or use of Skyworks products, information or materials, except as may be provided in Skyworks’ Terms and Conditions of Sale.

THE MATERIALS, PRODUCTS AND INFORMATION ARE PROVIDED “AS IS” WITHOUT WARRANTY OF ANY KIND, WHETHER EXPRESS, IMPLIED, STATUTORY, OR OTHERWISE, INCLUDING FITNESS FOR A PARTICULAR PURPOSE OR USE, MERCHANTABILITY, PERFORMANCE, QUALITY OR NON-INFRINGEMENT OF ANY INTELLECTUAL PROPERTY RIGHT; ALL SUCH WARRANTIES ARE HEREBY EXPRESSLY DISCLAIMED. SKYWORKS DOES NOT WARRANT THE ACCURACY OR COMPLETENESS OF THE INFORMATION, TEXT, GRAPHICS OR OTHER ITEMS CONTAINED WITHIN THESE MATERIALS. SKYWORKS SHALL NOT BE LIABLE FOR ANY DAMAGES, INCLUDING BUT NOT LIMITED TO ANY SPECIAL, INDIRECT, INCIDENTAL, STATUTORY, OR CONSEQUENTIAL DAMAGES, INCLUDING WITHOUT LIMITATION, LOST REVENUES OR LOST PROFITS THAT MAY RESULT FROM THE USE OF THE MATERIALS OR INFORMATION, WHETHER OR NOT THE RECIPIENT OF MATERIALS HAS BEEN ADVISED OF THE POSSIBILITY OF SUCH DAMAGE.

Skyworks products are not intended for use in medical, lifesaving or life-sustaining applications, or other equipment in which the failure of the Skyworks products could lead to personal injury, death, physical or environmental damage. Skyworks customers using or selling Skyworks products for use in such applications do so at their own risk and agree to fully indemnify Skyworks for any damages resulting from such improper use or sale.

Customers are responsible for their products and applications using Skyworks products, which may deviate from published specifications as a result of design defects, errors, or operation of products outside of published parameters or design specifications. Customers should include design and operating safeguards to minimize these and other risks. Skyworks assumes no liability for applications assistance, customer product design, or damage to any equipment resulting from the use of Skyworks products outside of Skyworks’ published specifications or parameters.

Skyworks, the Skyworks symbol, Sky5®, SkyOne®, SkyBlue™, Skyworks Green™, Clockbuilder®, DSPLL®, ISOModem®, ProSLIC®, and SiPHY® are trademarks or registered trademarks of Skyworks Solutions, Inc. or its subsidiaries in the United States and other countries. Third-party brands and names are for identification purposes only and are the property of their respective owners. Additional information, including relevant terms and conditions, posted at www.skyworksinc.com, are incorporated by reference.